

蓋受詳細

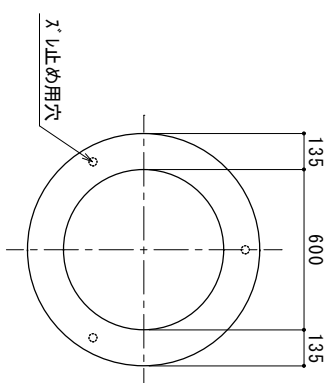

参考質量

品名	kg
蓋受	120
100A-350	590
100M-300	260
100B-550	840
合計	1,810

1000型-1200ハンドホール

図番	縮尺	製図	日付
KS-10-12	1/20	丸本	2023.07.06

